

# *mOuvée*

## **WINE CABINET - INSTRUCTION MANUAL**

**Models:** WSD49, WSD70, WCS15, WCD30-700, WCD30, WCS30PS-700, WCD30-780, WCD40-700, WCD50-700, WCD60-700, WCD60, WCD60P-700, WCD60P, WCDD60, WE2D60, WCS60PS-700, WCD60-780, WCD187H, WKED25P, WKD25, WKD49, WKD70, WKED112P, WSTO8177, WSTO82, WSTO78T, VCB100SS, VCB125SS, VCB170SS & VCB220SS.

Please read this manual carefully before installing and starting up, and store it in a safe place. If you pass on the product to another person, hand over this instruction manual along with it.

# TABLE OF CONTENTS

<b>1. IMPORTANT SAFEGUARDS</b>	<b>3</b>
1.1 For your safety	3
<b>2. DISPOSAL</b>	<b>6</b>
<b>3. CONNECTION TO THE MAINS SUPPLY</b>	<b>7</b>
<b>4. PRODUCT FEATURES</b>	<b>8</b>
<b>5. INSTALLATION</b>	<b>9</b>
5.1 Before using your appliance	9
5.2 Installation of your appliance	9
5.3 Electrical connection	14
5.4 Installing the handle	15
5.5 Reversing the door hinge	15
5.6 Anti-tip bracket installation	21
5.7 Securing the appliance	22
<b>6. OPERATING YOUR APPLIANCE</b>	<b>23</b>
6.1 Use and control - single zone with led display	23
6.2 Use and control - single zone with lcd display	25
6.3 Use and control - dual zone with led display	27
6.4 Use and control - dual zone with lcd display	29
6.5 Use and control - three zone with led display	31
6.6 Use and control - three zone with lcd display	33
6.7 Different modes	39
6.8 Bottle loading, noises and hygometry	40
<b>7. CARE AND MAINTENANCE</b>	<b>44</b>
<b>8. PROBLEMS WITH YOUR APPLIANCE</b>	<b>47</b>
8.1 Troubleshooting guide	47
<b>9. WARRANTY</b>	<b>50</b>

# 1. IMPORTANT SAFEGUARDS

When using an electrical appliance, basic precautions should always be followed to reduce the risk of fire, electric shock, and injury to persons, including the following:

## 1.1 For your safety

Read all instructions carefully, even if you are quite familiar with the appliance.

- The appliance is intended to be used for the storage of wine. Use this appliance only as described in this manual. Other uses not recommended may cause fire, electric shock or personal injury.
- In compliance with EN standards: This appliance can be used by children aged from 8 years and above and persons with reduced physical, sensory or mental capabilities or lack of experience and knowledge if they have been given supervision or instruction concerning use of the appliance in a safe way and understand the hazards involved. Children shall not play with the appliance. Cleaning and user maintenance shall not be made by children without supervision.
- In compliance with IEC standards: This appliance is not intended for use by persons (including children) with reduced physical, sensory or mental capabilities, or lack of experience and knowledge, unless they have been given supervision or instruction concerning use of the appliance by a person responsible for their safety. Children should be supervised to ensure that they do not play with the appliance.
- Electrical devices are not toys. Always keep the device out of the reach of children. Keep the mains cord out of the reach of children. Do not let the mains cord hang over the edge of the table or worktop on which the appliance stands.
- Children aged from 3 to 8 years are allowed to load and unload refrigerating appliances.
- To protect against the risk of electric shock, DO NOT IMMERSE the unit, cord, or plug in water or spray any other liquid.
- Unplug the appliance from the plug socket when not in use, when moving from one location to another and before cleaning.
- To disconnect the appliance, grip the plug and pull it from the wall outlet. Never pull by the cord.
- **WARNING!** Please keep the appliance away from substance, which can cause ignition. Do not operate the appliance in the presence of explosive and/or flammable fumes.
- Do not place the appliance or any of its part near an open flame, cooking or other heating appliance.
- Do not operate the appliance with a damage cord or plug, if the product malfunctions, or if it is dropped or damaged in any manner. If the SUPPLY CORD is damaged, it must be replaced by the manufacturer, or an authorized service centre or similarly qualified persons in order to avoid a hazard.

- The use of attachments not recommended by the manufacturer may be hazardous.
- Place the unit on a dry level surface.
- Do not operate if the housing is removed or damaged.
- A loose fit between the AC outlet (receptacle) and plug may cause overheating and a distortion of the plug. Contact a qualified electrician to replace loose or worn outlet.
- Locate the unit away from direct sunlight and sources of heat (stove, heater, radiator, etc.).
- **WARNING!** This appliance is CFC- and HFC- free and contains small quantities of Isobutane (R600a) which is environmentally friendly, but flammable. It does not damage the ozone layer, nor does it increase the greenhouse effect. Care must be taken during transportation and setting up of the appliance that no parts of the cooling system are damaged. Leaking coolant can ignite and may damage the eyes.
- In the event of any damage:
  - » Avoid open flames and anything which creates a spark,
  - » Disconnect from the mains,
  - » Air the room in which the appliance is located for several minutes and,
  - » Contact the Service Department for advice.
- The more coolant there is in an appliance, the larger the room it should be installed in. In the event of a leakage, if the appliance is in a small room, there is the danger of combustible gases building up. For every 8 g of coolant at least 1 cubic meter of room space is required. The amount of coolant in the appliance is stated on the data plate inside the appliance. It is hazardous for anyone other than an Authorised Service Person to carry out servicing or repairs to this appliance. In Queensland of Australia the authorized person must hold a Gas Work Authorisation for hydrocarbon refrigerants, before carrying out servicing or repairs which involve the removal of covers.
- **WARNING!** Keep ventilation openings, in the appliance enclosure or in the built-in structure, clear of obstruction. No liability will be accepted for any damage incurred owing to misuse of the appliance or as a result of repairs carried out by unqualified personnel. In this case neither the guarantee nor any other liability claims will apply.
- **WARNING!** Do not use mechanical devices or other means to accelerate the defrosting process, other than those recommended by the manufacturer.
- **WARNING!** Do not damage the refrigerant circuit. Never use an appliance with a damaged circuit.
- **WARNING!** Do not use any electrical appliance inside the food storage compartment of the appliance, unless they are of the type recommended by the manufacturer.
- **WARNING!** To avoid a hazard due to instability of the appliance, it must be fixed in accordance with the instructions.

- **CAUTION!** Please keep the products away from the fire or similar glowing substance before you dispose the appliance.
- **WARNING!** Do not store explosive substances such as aerosol cans with a flammable propellant in this appliance.
- **WARNING!** When position the appliance, ensure the supply cord is not trapped or damaged.
- **WARNING!** Do not locate multiple portable socket-outlets or portable power supplies at the rear of the appliance.
- **WARNING!** To avoid contamination of food, please respect the following instructions:
  - » Opening the door for long periods can cause a significant increase of the temperature in the compartments of the appliance.
  - » Clean regularly surfaces that can come in contact with food and accessible drainage system.
  - » Clean water tanks if they have not been used for 48 hours; flush the water system connected to a water supply if water has not been drawn for 5 days.
  - » Store raw meat and fish in suitable containers in the refrigerator, so that it is not in contact with or drip onto other food.
  - » Two-star frozen-food compartments are suitable for storing pre-frozen food, storing or making ice cream and making ice cubes.
  - » One, two and three-star compartments are not suitable for the freezing of fresh food.
  - » If the refrigerating appliance is left empty for long periods, switch off, defrost, clean, dry, and leave the door open to prevent mould developing with the appliance.
- Regarding the information pertaining to the use of the appliance, thanks to refer to the below paragraph of the manual.
- Regarding the method for replacing illuminating lamps (if the lamps can be replaced by the user), thanks to refer to the below paragraph of the manual.
- This appliance is intended to be used in household and similar applications such as:
  - » staff kitchen areas in shops, offices and other working environments;
  - » farm houses and by clients in hotels, motels and other residential type environments;
  - » bed and breakfast type environments;
  - » catering and similar non-retail applications.
- Do not attempt to repair or replace any part of your appliance unless it is specifically recommended in this manual. All other servicing should be referred to a qualified technician.

- Replace all panels after service before operating.
- **WARNING!** Glass breakage. Danger of injury from broken glass. If installed at altitudes above 1500m there is a risk of the glass in the door breaking because of changes in air pressure. Shards of glass can cause severe injury if not handled with care.
- Use two or more people to move and install the appliance. Failure to do so can result in back or other injury.
- Never clean appliance parts with flammable fluids. These fumes can create a fire hazard or explosion. And do not store or use gasoline or other flammable vapors and liquids in the vicinity of this or any other appliance. The fumes can create a fire hazard or explosion.
- Do not connect or disconnect the electric plug when your hands are wet.
- It is recommended that a separate circuit, serving only your appliance be provided. Use receptacles that cannot be turned off by a switch or pull chain.
- If you have a lockable appliance, do not keep the key near the appliance or within reach of children.
- If you have lost the instruction manual, please contact the local agent or send us an email for the electronic version.

**WARNING!** To reduce the risk of fire, electric shock or personal injury, unplug or disconnect the appliance from the power supply before servicing.

## SAVE THESE INSTRUCTIONS

If you are experiencing problems, check the Troubleshooting Guide at the back of this manual. It lists causes of minor operating problems that you can correct by yourself.

## 2. DISPOSAL

Dispose of your appliance packaging properly. Ensure that any plastic wrappings, bags etc. are disposed of safely and kept out of the reach of babies and young children. **Danger of suffocation!**

Refrigeration equipment must be properly disposed of in a professional and appropriate way, in accordance with the current local regulations and laws which protects the environment this applies to your old appliance and to your new unit once it has reached the end of its service life.

**WARNING!** Please ensure that old, worn appliances are rendered unusable before disposal by removing the doors, removing the plug, cutting the network cable, and removing or destroying any snap fastenings or bolts. You will thus prevent children from locking

themselves in the appliance during play (risk of suffocation) or endangering their lives in any other way. DO NOT dispose of the appliance in landfill as the insulation (Cyclopentane) and refrigerant gas (R600a) contained in these appliances are flammable.

Disposal instructions:

- The appliance must not be disposed of in the dustbin or with normal household rubbish.
- The coolant circuit, particularly the heat exchanger at the back/bottom of the unit, must not be damaged.
- The  symbol on the product or its packaging indicates that this product is not to be handled as normal household waste but is to be taken to a recycling collection point for electrical and electronic goods. By correctly disposing of this product you are contributing to the protection of the environment and to the health of your fellow human beings. Improper disposal endangers health and the environment. Further information about the recycling of the product may be obtained from your town hall, refuse collection department or the store where you purchased the product.

## 3. CONNECTION TO THE MAINS SUPPLY UK, IRL, HK, SINGAPORE

Check that the voltage marked on the product corresponds with your supply voltage.

This product is fitted with a 13A plug complying with BS1363. If this plug is unsuitable or needs to be replaced, please note the following:

**WARNING! THIS APPLIANCE MUST BE EARTHED.**

Important: The wires in the mains lead are coloured in accordance with the following code:

GREEN/YELLOW - EARTH

BLUE - NEUTRAL

BROWN - LIVE

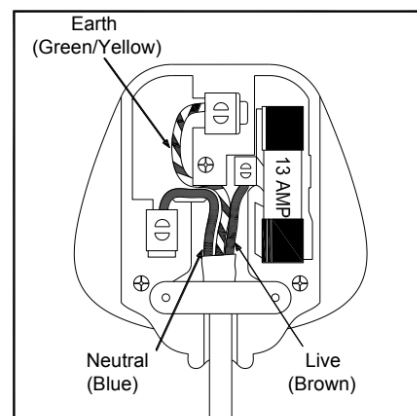

This appliance is equipped with a plug fitted with a 13 amp fuse. Should the fuse fail, then it must be replaced with an ASTA approved fuse (conforming to BS1362) of the same rating. If you need to replace the plug or if the plug is of the incorrect type for your socket, remove it and replace it with an appropriate type. Dispose of the old plug safely.

As the colours of the wires in the mains lead of this appliance may not correspond with the coloured markings identifying the terminals in your plug, proceed as follows: The **GREEN/**

**YELLOW** wire is the **EARTH** and must be connected to the terminal which is marked with the letter 'E' or by the earth symbol  or coloured **GREEN** or **GREEN/YELLOW**.

The **BLUE** wire is the **NEUTRAL** and must be connected to the terminal which is marked with the letter 'N' or coloured **BLACK**.

The **BROWN** wire is the **LIVE** wire and must be connected to the terminal which is marked with the Letter 'L' or coloured **RED**.

Always ensure that the plug cord grip is fastened correctly.

If in doubt consult a qualified electrician who will be pleased to do this for you. This product conforms to all statutory safety standards.



**DANGER**  
Electric  
Shock Risk



## 4. PRODUCT FEATURES

- Built-in or Free-standing installation with single, dual or three temperature zone, depending on your model.
- Continuously variable electronic temperature control with digital display and SMARTLIGHT touchpad input.
- Temperature can be set from 5° to 20°C (41° to 68°F ) for either compartment and can be displayed in either Fahrenheit or Celsius degree.
- Can be set to the long time storage maturing temperature or a specific serving temperature for red/white/sparkling wines.
- Cooling and Heating to maintain the perfect storage and/or service condition.
- Dynamic compressor type cooling to ensure interior air circulation with even distribution of temperature and humidity.
- Soft LED Interior Light with ON/OFF switch – Function mode and Showcase mode.
- Open-door and malfunction warning system.
- Sabbath mode will allow the lights to remain off during certain religious observances.
- Temperature memory function - If power is interrupted (power surge, breaker switch, etc.) and then powered up again, the unit will operate with the last temperature set-point.



- Automatic defrosting with defrost water evaporation.
- Reversible tempered double/triple pane smoked glass door protects your wine from UV light and creates an attractive display with minimal condensation and low noise.
- Black coated matte steel outer frame and black plastic interior liner offer lifetime performance and stability. The black liner prevents excessive light from damaging the maturing process.
- Optional stainless steel-framed glass door with stainless steel handle.
- Optional roll-out and adjustable solid varnished beech shelves allow for maximum convenience and flexibility to accommodate various size bottles.
- Environmentally friendly refrigerant and foaming insulation gas.
- Optional security lock system with keys.
- Optional humidity control system (Humidity Box).
- Optional active charcoal air filter.

## 5. INSTALLATION

### 5.1 Before using your appliance

- Remove all exterior and interior packing. Clean the interior surface with lukewarm water using a soft cloth. The unit may have residual odors at first, they will disappear as the unit cools.
- Before connecting the appliance to the power source, let it stand upright for at least 24 hours. This will reduce the possibility of a malfunction in the cooling system caused by handling during transportation to ensure that oil flows back into the compressor. During this time we recommend that you leave the door open to clear any residual odors.
- The door on this appliance can be opened from either the left or the right side. The unit is delivered with the door opening on the left side. Should you wish to open the door from the right, follow the instructions 'Reversing the door hinge'.
- Install the handle on the door if necessary.

**NOTE!** Features and specifications are subject to change without notice.

### 5.2 Installation of your appliance

- The appliances are designed to be built-in or recessed or freestanding installation depending on your model. For the freestanding installation only models, it is not intended to be used as a built-in appliance.

- **WARNING!** Do not store or install the appliance outdoors. The unit is for indoor use only.
- **WARNING!** Do not install the appliance in the laundry. Avoid locating the unit in damp areas.
- Place your appliance on a floor/surface that is strong enough to support it when it is fully loaded. To level your unit, adjust the front leveling leg at the bottom of the unit.
- For freestanding installation, 100mm of space between the back and sides of the unit are suggested, which allows the proper air circulation to cool the compressor and condenser for energy saving. Even with built-in installation, it is a must to keep 5mm space on each side and at the top to ensure proper service access and ventilation. Take care that the air vent at the front of the appliance must never be covered or blocked in any way.
- Locate the unit away from direct sunlight and sources of heat (stove, heater, radiator, etc.). Direct sunlight may affect the acrylic coating and heat sources may increase electrical consumption. Extreme cold ambient temperatures may also cause the unit not to perform properly.
- Plug the unit into an exclusive, easily accessible plug socket. Any questions concerning power and/or grounding should be directed towards a qualified electrician or an authorized products service centre.
- The appliance must be installed to all electrical, plumbing, water and drain connections in accordance with state and local codes.
- **IMPORTANT! HIGH HUMIDITY CLIMATE.** During periods of high humidity, some condensation may appear on outside surface of glass door. This condensation will disappear when humidity levels drop. For prevention, it is advisable to install the appliance with sufficient ventilation in a dry and/or an air-conditioned place or switch on the **ANTI-CONDENSATION MODE** if available.

**NOTE!** The appliance must be positioned so that the plug is accessible.

### 5.2.1 BUILT-UNDER INSTRUCTIONS

Make sure your installation does not block the front ventilation grille. The unit is designed to fit under worktops between 820 and 890mm in height, using the height-adjustable ventilation grille to ensure that the feet are concealed from front view. Remove the adjustable ventilation grille screws and slide it to the required height. Tighten the screws to lock the grille in position.

If the unit is fully integrated to be installed for fitting kitchen plinth, make sure that the ventilation gaps in the plinth are at least 300 square centimeters and remove the ventilation grilles, so that warm air can disperse unhindered. Otherwise the appliance has to work harder, resulting in an increase in electricity consumption.

**NOTE!** When pushing the appliance into the niche, make sure that the mains cable does not get trapped.

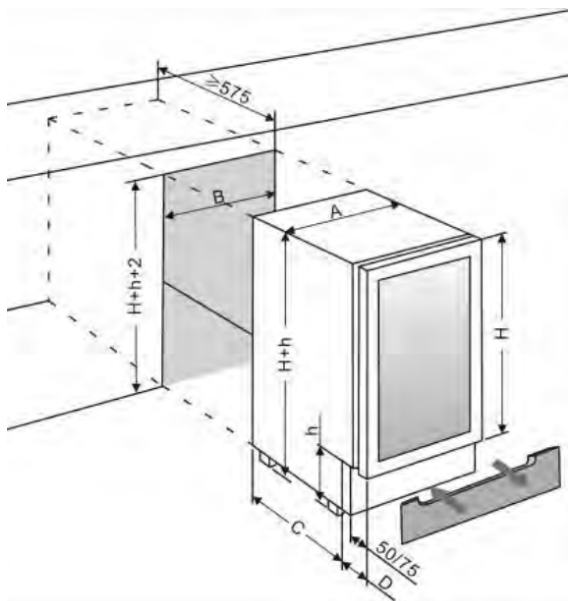

	A (mm)	B (mm)	C (mm)	D (mm)
<b>15 cm wide</b>	148	150	455	75
<b>30 cm wide</b>	295	300	440/460	115
<b>40 cm wide</b>	395	400	460	115
<b>50 cm wide</b>	495	500	460	115
<b>60 cm wide</b>	595	600	440/460	115

**NOTE!**

**H** – Can be 700, 720, 780 or 800mm and it depends on the actual product specification.

**h** – Can be 80, 100, 120 or 150mm and it depends on the actual product specification. The standard maximum adjustable height for plinth is 70mm. If you need the more adjustable height legs, they can be purchased from your dealer or from the Spare Parts Department.

For flush inset built-in installation, an extra 3mm door clearance is required for dimension B.

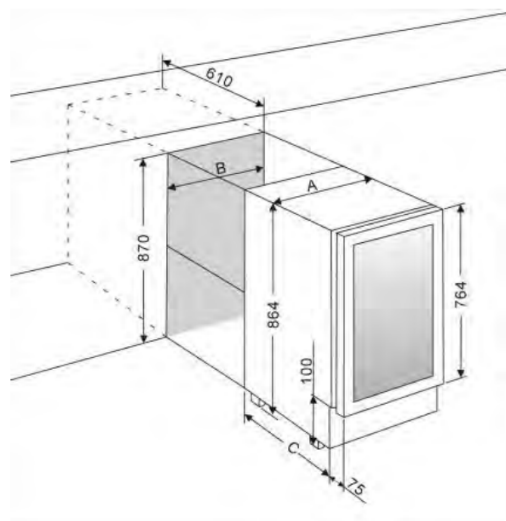

	A (mm)	B (mm)	C (mm)
<b>37.5 cm wide</b>	375	380	495
<b>44.5 cm wide</b>	445	450	520
<b>60 cm wide</b>	595	610	520
<b>75 cm wide</b>	750	760	520

## 5.2.2 FULLY INTEGRATED BUILT-IN-COLUMN INSTRUCTIONS

**RISK OF DAMAGE!** The wine cabinet has an elongated glass door and must not be set down vertically at any time!

**DESIGN 1** – The unit door seals the installed unit almost completely, so an air vent must be provided in the base of the housing. Warmed air must be conducted via the ventilation shaft to the rear wall of the housing and then expelled upwards. The ventilation channels should measure at least 200 square centimeters in cross-section.

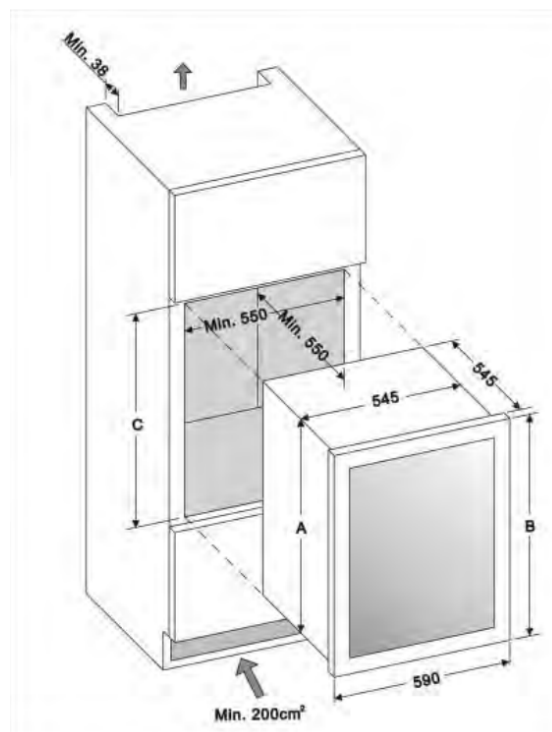

Aperture	A (mm)	B (mm)	C (mm)
45 cm H	448	455	450
60 cm H	588	595	590
88 cm H	878	885	880
122 cm H	1221	1234	1225-1230
178 cm H	1771	1784	1775-1780

**WARNING!** To ensure the proper functioning of the appliance, air vents should never be blocked or covered.

**Remark:** The dimension A does not include the adjustable legs and the units are permitted to be installed without the adjustable legs.

**DESIGN 2** - Air at the back of the unit gets warm. The unit is equipped with an integrated ventilation system to disperse the warm air automatically. Air intake is provided underneath the appliance door and the air escapes at the top of the door. The air inlet and outlet must not be covered or blocked in any way. They must also be regularly cleaned of dust.

After installation make sure that the appliance door opens and closes properly.

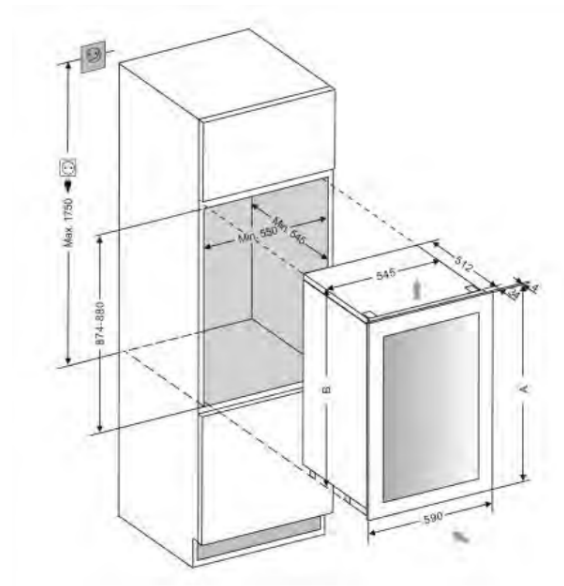
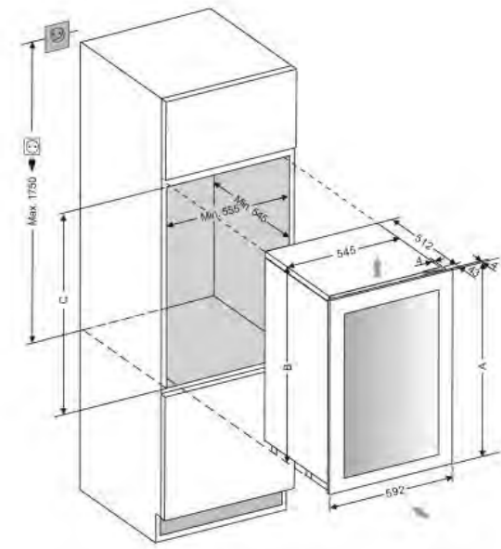

Aperture	A (mm)	B (mm)	C (mm)
45 cm H	450	449	450
60 cm H	590	588	589-593
68 cm H	715	674	675-685
88 cm H	885	872	874-880
122 cm H	1234	1221	1223-1230
178 cm H	1784	1771	1773-1780

**WARNING!** If the ventilation gaps given are not observed, the compressor will run more frequently and for longer periods. This will result in increased energy consumption and a higher operating temperature for the compressor. This may, in turn, cause damage to the compressor. It is essential to observe the ventilation gaps given.

### 5.2.3 BUILT-IN CABINETY INSTRUCTIONS

Make sure your installation does not block the front ventilation grille. And be sure the door will open and close properly in the chosen location.

	a (mm)	b (mm)	c (mm)
100	1476	575	595
125	1768	575	595
170	1768	680	595
125S	1820	575	595
170S	1820	680	595
220	1820	680	680

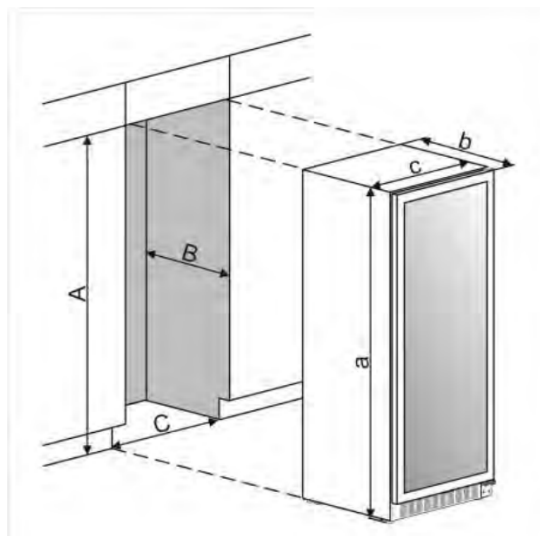

**NOTE!** To ensure proper service access and ventilation, A must be at least 5mm more than a, B must be at least 5mm more than b and C must be at least 5mm more than c. For flush inset built-in installation, an extra 3mm door clearance is required for dimension C.

### 5.3 Electrical connection

**WARNING!** Improper use of the grounded plug can result in the risk of electrical shock. If the power cord is damaged, have it replaced by a qualified electrician or an authorized service center.

All electrical work should be carried out by a suitably qualified and competent person in accordance with local and national safety regulations.

Check that the voltage marked on the product corresponds with your supply voltage.

Connect this appliance to a separate at least 13A circuit.

Connection should be made via a suitable switched socket which is easily accessible. For extra safety it is advisable to install a residual current device (RCD) with a trip current of 30mA.

Have the receptacle and the circuit checked by a qualified electrician to ensure that the socket is grounded correctly.

**NOTE!** In locations where there is frequent lightning, it is advisable to use surge protectors. Do not connect the appliance to the mains electricity supply by an extension lead.

Extension leads do not guarantee the required safety of the appliance (e.g. danger of overheating).

The appliance must not be connected to an inverter and must not be used with a plug adapter as these can cause damage to the appliance's electronic unit.

The cord must rest securely behind the appliance and not be allowed to lie or hang unprotected.

**WARNING!** This appliance must be earthed.

## 5.4 Installing the handle

**IMPORTANT!** Do not overtighten the screws & do not use power tools to install the handle.

**DESIGN 1** - Locate the handle (1) over the mounting stubs (3) of the door and tighten the grub screws (2) with an Allen key to secure the handle.

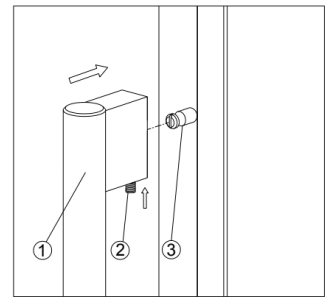

**DESIGN 2** –

1. Remove the door gasket (2) on the side you wish to install the handle - you can see two designated holes for handle installation.
2. Install the handle (4) tightly as shown above with two screws (1) and flat washers (3) provided.
3. Replace the door gasket.

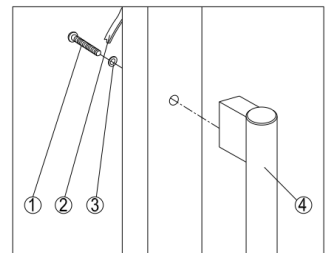

## 5.5 Reversing the door hinge

It is possible to reverse the door on this appliance, if required. To do so, follow the steps below:

**NOTE!** All parts removed must be saved to do the reinstallation of door.

## DESIGN 1 – For built-under models

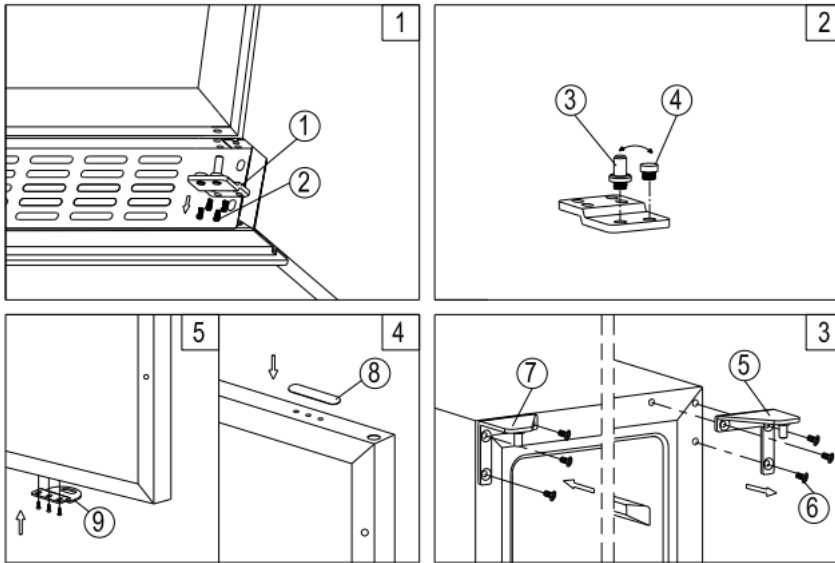

1. Remove the bottom hinge (1) by unscrewing the four lock screws (2). Be careful to hold the glass door firmly after removing the screws. (Fig. 1)
2. Gently pull down to remove the glass door from the right top hinge and place it on a padded surface to avoid the risk of damage. Then remove the right top hinge (5). (Fig. 3)
3. Unscrew and transfer hinge pin (3) and/or door stopper (4) of the bottom hinge to the opposite side. (Fig. 2)
4. Pop out the cover caps on the left side of cabinet and use them to cover the screw holes on the right hand side.
5. Screw the alternative left top hinge (7), included in the fittings, on the left hand side of cabinet. (Fig. 3)
6. Unscrew and transfer the holes cover (8) and lock catch (9) to the opposite side of glass door. (Only for models with lock on the ventilation grille) (Fig. 4)
7. Rotate the door 180° (No need for models with lock on the door) and relocate the door to the designated position. Then screw the bottom hinge assembly on the left designated position and tighten it after the door is leveled.
8. Transfer the handle & plugs to the opposite positions if need.



## DESIGN 2 – For fully integrated models

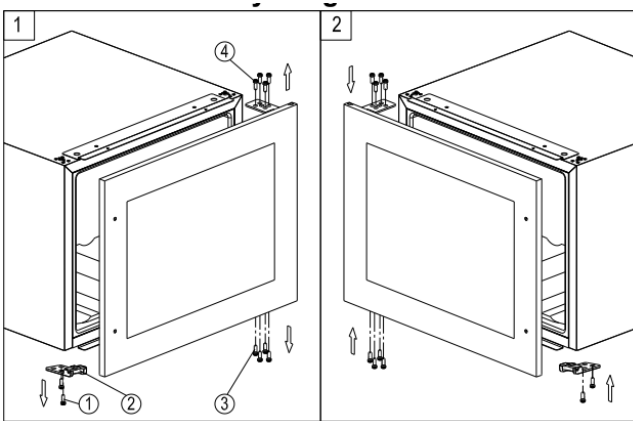

1. Remove the glass door by unscrewing the eight lock screws (3) and (4). Be careful to hold the glass door firmly after removing the screws and place it on a padded surface to avoid the risk of damage.
2. Unscrew and transfer the door supporter (2) to the opposite side.
3. Rotate the glass door 180° and refit the glass door to the opposite side. Then screw and tighten it after the door is leveled.

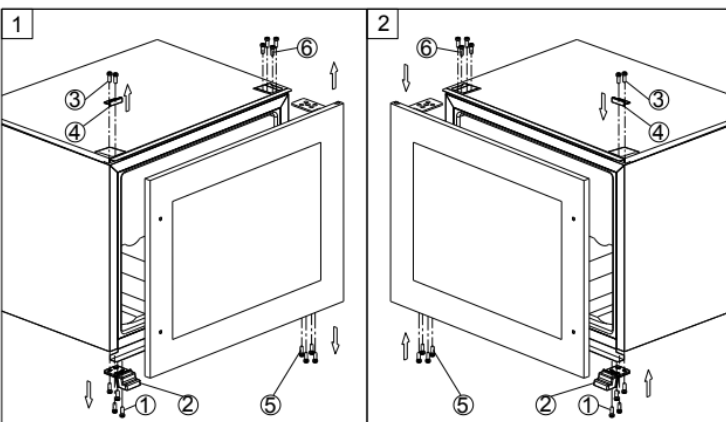

1. Remove the glass door by unscrewing the eight lock screws (5) and (6). Be careful to hold the glass door firmly after removing the screws and place it on a padded surface to avoid the risk of damage.
2. Unscrew the screws (1) and (3) then transfer the door supporter (2) and decoration cover (4) to the opposite side.
3. Rotate the glass door 180° and refit the glass door to the opposite side. Then screw and tighten it after the door is leveled.

## DESIGN 3 – For tall models

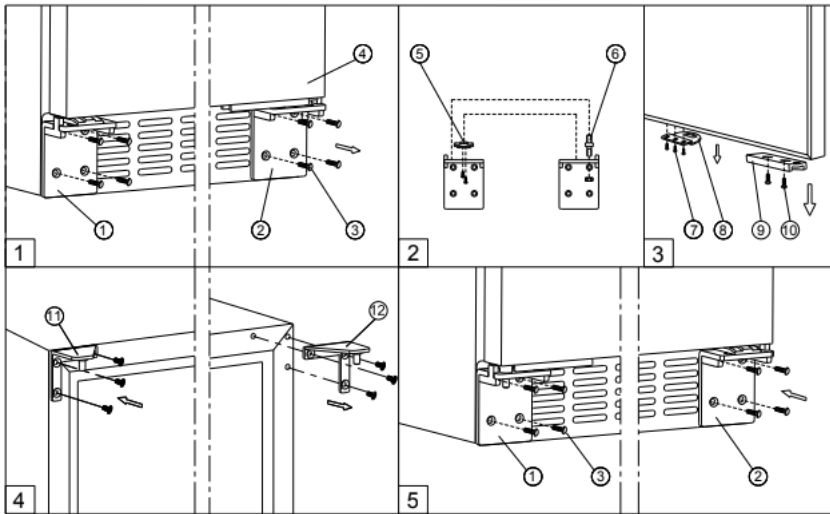

1. Remove the right bottom hinge (2) and/or left bottom hinge (1) by unscrewing the eight lock screws (3). Be careful to hold the door (4) firmly after removing the screws. (Fig. 1)
2. Gently pull down to remove the door from the right top hinge and place it on a padded surface to avoid the risk of damage. Then remove the right top hinge (12). (Fig. 4)
3. Pop out the cover caps on the left side of cabinet and use them to cover the screw holes on the right hand side.
4. Screw the alternative left top hinge (11), included in the fittings, on the left hand side of cabinet. (Fig. 4)
5. Unscrew and transfer hinge pin (6) and/or door supporter (5) to the opposite bottom hinge. (Fig. 2)
6. Unscrew and transfer the door adapter (9) and/or lock catch (8) to the top designated positions of the door. (Fig. 3)
7. Rotate the door 180° and relocate it to the designated position. Then screw the bottom hinges on the designated positions and tighten them. (Fig. 5)
8. Recheck and adjust the door alignment by loosening the screws (10) and moving the door adapter (9). Tighten the screws (10) after the door is levelled. (Fig. 5)

## DESIGN 4 – For vertical double door models

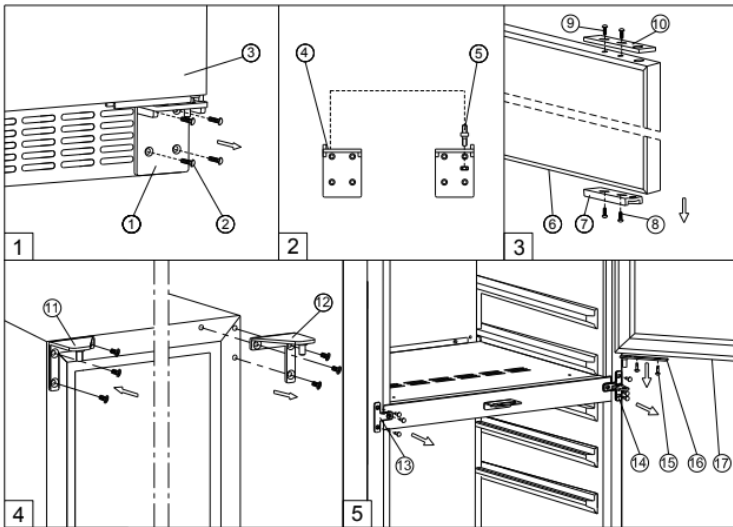

1. Remove the right bottom hinge (1) by unscrewing the four screws (2). Be careful to hold the lower glass door (3) firmly after removing the screws. And then gently pull down to remove the lower glass door from the middle hinge and place it on a padded surface to avoid the risk of damage. (Fig. 1)
2. Unscrew and transfer the door adapter (7) and (10) to the designated opposite position of lower glass door. At the same time unscrew and transfer hinge pin (5) of the left bottom hinge (4) included in the fittings. (Fig. 2 & 3)
3. Remove the door adapter (16) by unscrewing the two lock screws (15). Be careful to hold the upper glass door firmly after removing the screws. And then gently pull down to remove the upper glass door (17) from the top hinge and place it on a padded surface to avoid the risk of damage. Then remove the right top hinge (12). (Fig. 5 & 4)
4. Unscrew and transfer the middle hinge (14) and the middle fixing plate (13) to the opposite position. (Fig. 5)
5. Pop out the cover caps on the left side of cabinet and use them to cover the screw holes on the right hand side.
6. Screw the alternative left top hinge (11), included in the fittings, on the left hand side of cabinet. (Fig. 4)
7. Relocate the door adapter (16) on the middle hinge.
8. Set the upper glass door to the designated position and install the two lock screws to connect the door adapter (16) with the upper glass door and tighten them before the door is leveled.
9. Set the lower glass door to the designated position. Then screw the left bottom hinge on the left designated position and tighten them.

10. Recheck and adjust the lower door alignment by loosening the screws (8) & (9) and moving the door adapter (7) & (10). Tighten the screws (8) & (9) after the door is levelled.
11. Transfer the handles and plugs to the opposite positions.

### DESIGN 5 – For models with articulated hinge

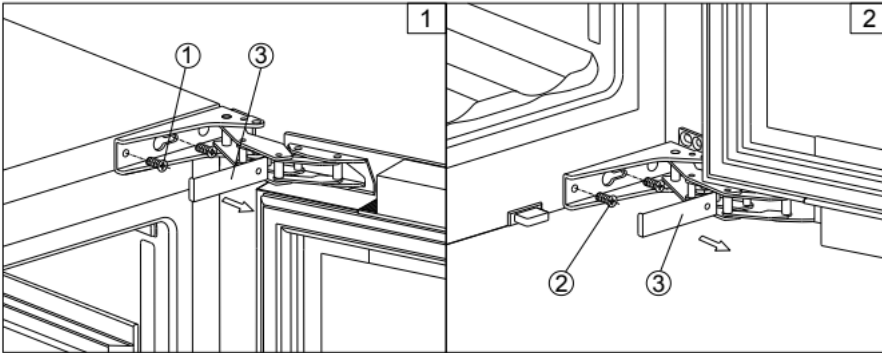

**WARNING!** Use extreme caution with the articulated hinges. The hinge is self-closing and many pinch points exist prior to built-in installation.

1. Remove the cover caps (3) and then remove the glass door by unscrewing the four screws (1) and (2). Be careful to hold the glass door firmly after removing the screws and place it on a padded surface to avoid the risk of damage.
2. Pop out the cover caps on the left side of cabinet and use them to cover the screw holes on the right hand side.
3. Rotate the glass door 180° and refit the glass door to the opposite side. Then screw and tighten it after the door is levelled.

## DESIGN 6 – For freestanding models

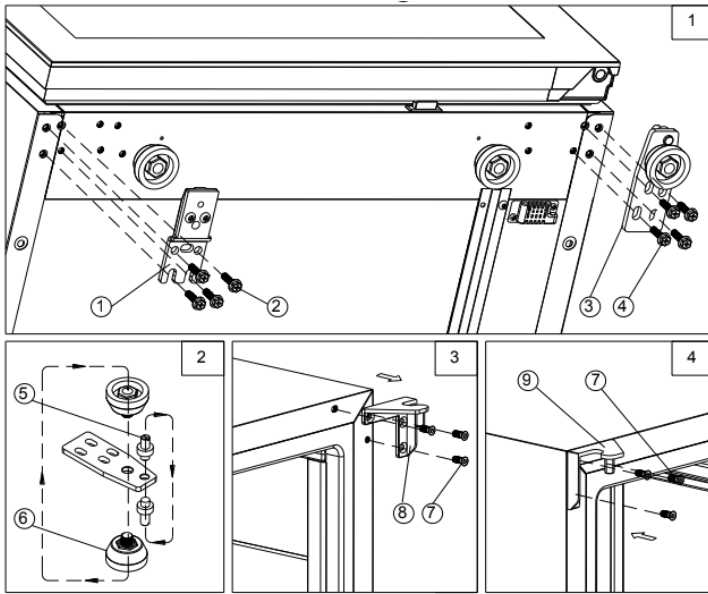

1. Remove the bottom hinge (3) by unscrewing the four lock screws (4). Be careful to hold the glass door firmly after removing the screws. (Fig. 1)
2. Gently pull down to remove the glass door from the right top hinge and place it on a padded surface to avoid the risk of damage. Then remove the right top hinge (8). (Fig. 3)
3. Unscrew and transfer hinge pin (5) and adjustable leg (6) of the bottom hinge to the opposite side. (Fig. 2)
4. Pop out the cover caps on the left side of cabinet and use them to cover the screw holes on the right hand side.
5. Screw the alternative left top hinge (9), included in the fittings, on the left hand side of cabinet. (Fig. 4)
6. Unscrew the four lock screws (2) and transfer the door supporter (1) to the opposite side. (Fig. 1)
7. Rotate the door 180° and relocate the door to the designated position. Then screw the bottom hinge assembly on the left designated position and tighten it after the door is leveled.

## 5.6 Anti-tip bracket installation

To reduce the risk of tipping the unit by abnormal usage or improper loading, the appliance must be secured by properly installing the anti-tip device (if your model supplied with it) packed with the appliance.

- Place the anti-tip bracket on the floor as shown in the figure. An anti-tip bracket can be installed at the left side.
- Mark the locations of the 4 holes of the anti-tip bracket on the floor.

- Use an 8mm / 5/16" masonry drill bit and insert plastic anchors.
- Secure bracket to floor using screws.
- Slide appliance into position and make sure the leg engages the anti-tip bracket.

**NOTE!** If the unit is relocated, the bracket must be removed and installed in the new location.

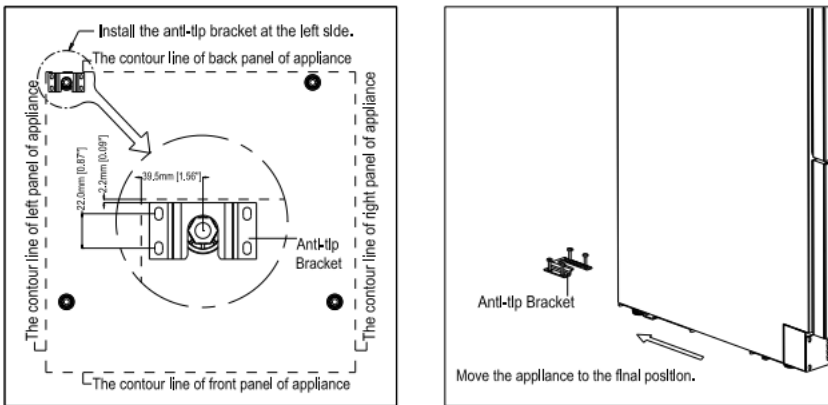

## 5.7 Securing the appliance

Pop out the two cover caps on the opposite side of hinge and secure the appliance in the niche by tightening the screws through the attachment bracket if the unit is provided with an attachment bracket.

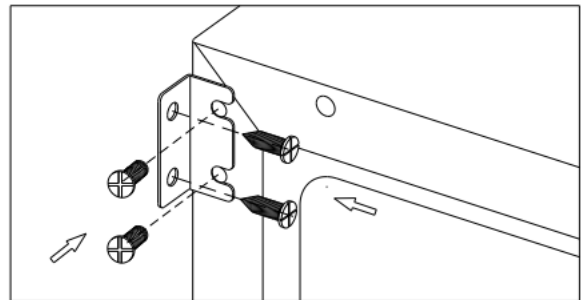
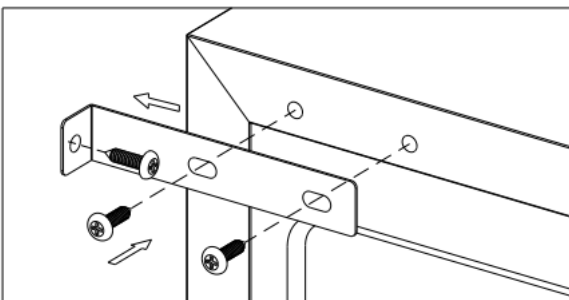

For some models with articulated hinges, you can directly secure the appliance in the niche by tightening the screws through the articulated hinge.

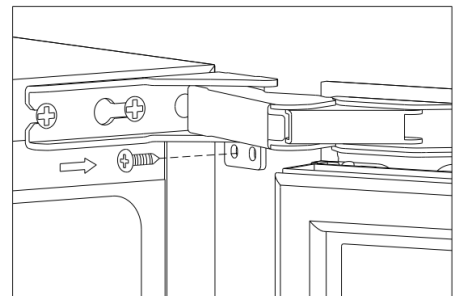

## 6. OPERATING YOUR APPLIANCE

This appliance is designed for operation at certain ambient temperatures. The climatic class is specified on the rating plate.

The appliance may not work properly if it is left for a long period at a temperature outside the specified range. For example, placing your unit in extreme cold or hot conditions may cause interior temperatures to fluctuate. The range between 5°C and 20°C (41°F and 68°F) may not be reached.

Climatic class	Ambient room temperatures
SN	+10°C to +32 °C
N	+16 °C to +32 °C
ST	+16 °C to +38 °C
T	+16 °C to +43 °C

### NOTE!

- A unit with no heater will not raise its internal temperature if the ambient temperature where the unit is located is lower than the set temperature.
- When you use the appliance for the first time or restart the appliance after having been shut off for a long time, there could be a few degrees variance between the temperature you select and the one indicated on the LCD readout. This is normal and it is due to the length of the activation time. Once the unit is running for a few hours everything will be back to normal.
- If the unit is unplugged, has lost power, or is turned off, you must wait 3 to 5 minutes before restarting the unit. If you attempt to restart before this time delay, the unit will not start.

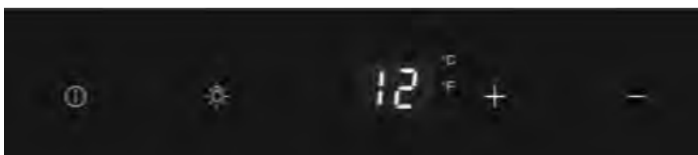

### 6.1 Use and control - single zone with led display

#### The Controls of Your Unit



**Power** ① - To turn the appliance off, lightly touch and hold ① the key for 5 seconds until temperature display goes out. To turn the appliance on, lightly touch and hold ① the key for 1 second until temperature display lights up.

**NOTE!** Touching the  key once can switch off the audible alarm when the alarm is on.

**LIGHT**  - To turn the interior light on/off, lightly touch and hold the  key for 5 seconds. The interior light indicator will light up or go out to confirm the selection.

**UP**  - Used to increase (warm) the set temperature by 1°C/1°F.

**DOWN**  - Used to decrease (cool) the set temperature by 1°C/1°F.

## Display

Display the digital temperature and service indicators.

## Light indicator / Multi-key Function

The interior light indicator is the dot at the bottom right of the display. The interior light indicator will light up in showcase mode. The interior light indicator will flash when the multi-key function is selected. To perform the multi-key function, lightly touch and hold the first key, then touch the rest key for at least 5 seconds and then release all the keys.

## °F/°C Selector

Select the temperature display setting in Fahrenheit or Celsius degree. To change the temperature from Fahrenheit to Celsius or from Celsius to Fahrenheit, touch and hold the **LIGHT** key for 5 seconds.

## Child Lock

If in 2 minutes or longer without touching any key, the child lock will be activated automatically for models with the control outside of cabinet. To cancel the lock, touch the **UP** and **DOWN** keys at the same time for at least 5 seconds and the indicator light will flash three times to confirm the action.

## Setting the Temperature Control

- The unit has a single adjustable temperature zone. The temperature can be set between 5°C and 20°C (41°F and 68°F). It can be used as a wine maturing cabinet or a wine serving cabinet. The recommended temperature setting range for maturing wine is between 11°C and 14°C (52°F and 57°F). The recommended temperature setting range for serving white wine is between 5°C and 10°C (41°F and 50°F) and the recommended temperature setting range for serving red wine is between 15°C and 20°C (58°F and 68°F).
- When the unit is plugged in for the first time, the unit will power up automatically to the preset defaults. The temperature preset at the factory is 12°C (54°F) (ideal maturing temperature).
- You can set the temperature as required by touching the **UP** or **DOWN** key. When you touch either key at the first time, the display will show the last temperature set previously. The temperature will increase 1°C/1°F if you touch the **UP** key once, or the





temperature will decrease 1°C/1°F if you touch the DOWN key once. The display flashes while you make the setting.

- After the temperature has been set, the display shows the current inner temperature.
- To view the set temperature at any time, touch the UP or DOWN key; the set temperature will temporarily flash in the display for 5 seconds. Then the display shows the current inner temperature again.

## 6.2 Use and control – single zone with lcd display



### The Controls of Your Unit



**Power**  - To turn the appliance off, lightly touch and hold  the key for 5 seconds until temperature display goes out. To turn the appliance on, lightly touch and hold  the key for 1 second until temperature display lights up.

**NOTE!** Touching the  key once can switch off the audible alarm when the alarm is on.

**°F/°C SELECTOR**  - Set the temperature to be displayed in degree Fahrenheit or degree Celsius.







**LIGHT**  - To turn the interior light on/off, lightly touch and hold the  key for 5 seconds.







**UP**  - Used to increase (warm) the set temperature by 1°C/1°F.

**DOWN**  - Used to decrease (cool) the set temperature by 1°C/1°F.

**Setting Selector**  - Select the temperature and humidity you want to set.

### Symbols in the Display

	Temperature or Error code display
	Compressor is ON
	Heater is ON
	Defrosting mode
	Dynamic Climate mode
DEMO	Eco Demo mode
	The interior light is in Showcase mode

	Warning
	Audible tones signal
	Child lock is activated
	Wifi connection signal
	Anti-condensation mode
	Relative humidity display



## Multi-key Function

To perform the multi-key function, lightly touch and hold the first key, then touch the rest key for at least 5 seconds and then release all the keys.

## Child Lock

(Only for models with outside controls) If in 2 minutes or longer without touching any key, the child lock will be activated automatically. To remove the lock, lightly touch the UP and DOWN keys at the same time for at least 5 seconds until the symbol is go out.

## Setting the Temperature Control

- The unit has a single adjustable temperature zone. The temperature can be set between 5°C and 20°C (41°F and 68°F). It can be used as a wine maturing cabinet or a wine serving cabinet. The recommended temperature setting range for maturing wine is between 11°C and 14°C (52°F and 57°F). The recommended temperature setting range for serving white wine is between 5°C and 10°C (41°F and 50°F) and the recommended temperature setting range for serving red wine is between 15°C and 20°C (58°F and 68°F).
- When the unit is plugged in for the first time, the unit will power up automatically to the preset defaults. The temperature preset at the factory is 12°C (54°F) (ideal maturing temperature).
- Touch the **Setting Selector**  until the temperature you want to set is flashing. Then you can use the UP and DOWN keys to set the internal temperature as required. When you touch either key at the first time, the display will show the last temperature set previously.
- The temperature will increase 1°C/1°F if you touch the UP key once, or the temperature will decrease 1°C/1°F if you touch the DOWN key once. The display flashes while you make the setting.
- The set temperature will temporarily flash in the display for 5 seconds after the temperature has been set. Then the display shows the current inner temperature again.
- To view the set temperature at any time, touch the Setting Selector key , the set temperature will temporarily flash in the display for 5 seconds. Then the display shows the current inner temperature again.



## Setting the Humidity Control

- Humidity level can be kept automatically for models with humidity pump.
- Touch the **Setting Selector**  until the humidity display <sup>RH</sup> % is flashing. Now you can use the UP and DOWN key to choose the relative humidity setting from 50% to 80% and 00%. The set humidity will temporarily flash in the display for 5 seconds. Then the display shows the current inner humidity again. The humidity preset at the factory is 70% (ideal wine storage humidity).
- When 00% is selected, the humidity pump will be switched off. The humidity pump increases the energy consumption of the unit. If the function is not necessary, please switch it off. The rated energy consumption is based on the function is switched off.



## 6.3 Use and control – dual zone with led display

### The Controls of Your Unit



**POWER**  - To turn the appliance off, lightly touch and hold the  key for 5 seconds until temperature display goes out. To turn the appliance on, lightly touch and hold the  key for 1 second until temperature display lights up.

**NOTE!** Touching the  key once can switch off the audible alarm when the alarm is on.



**LIGHT**  - To turn the interior light on/off, lightly touch and hold the  key for 5 seconds. The interior light indicator will light up or go out to confirm the selection.



**UP**  - Used to increase (warm) the set temperature by 1°C/1°F.

**DOWN**  - Used to decrease (cool) the set temperature by 1°C/1°F.

## Display

Display the digital temperature and service indicators.

 is for the **UPPER** temperature zone and  is for the **LOWER** temperature zone.

 is for the **LEFT** temperature zone and  is for the **RIGHT** temperature zone.

## Light indicator / Multi-key Function

The interior light indicator is the dot at the bottom right of the display. The interior light indicator will light up in showcase mode. The indicator light is the dot at the bottom right of the display. The indicator light will be on when the multi-key function is selected. To perform the multi-key function, lightly touch and hold the first key, then touch the rest key for at least 5 seconds and then release all the keys.

## °F/°C Selector

Select the temperature display setting in Fahrenheit or Celsius degree. To change the temperature from Fahrenheit to Celsius or from Celsius to Fahrenheit, lightly touch and hold the **LIGHT** key for 5 seconds.

## Child Lock

If in 2 minutes or longer without pressing any key, the child lock will be activated automatically for models with the control outside of cabinet. To cancel the lock, lightly touch the UP and DOWN keys at the same time for at least 5 seconds and the indicator light will flash three times to confirm the action.

## Setting the Temperature Control

- The unit has two separate temperature zones. The temperature of both zones can be set between 5°C and 20°C (41°F and 68°F). It can be used as a wine maturing cabinet or a wine serving cabinet. For maturing wine, the recommended temperature setting ranges of both zones should be between 11°C and 14°C (52°F and 57°F). For serving wine, the recommended temperature setting range of UPPER/LEFT zone should be between 5°C and 10°C (41°F and 50°F) which is ideal for serving champagne & white wine and the recommended temperature setting range of LOWER/RIGHT zone should be between 15°C and 20°C (58°F and 68°F) which is ideal for serving red wine.
- When the unit is plugged in for the first time, the unit will power up automatically to the preset defaults. The preset temperature at the factory for UPPER/LEFT temperature zone is 8°C (46°F) and for LOWER/RIGHT temperature zone is 12°C (54°F).
- You can touch the left side UP and DOWN keys to control the internal temperature of the UPPER/LEFT temperature zone and touch the right side UP and DOWN keys to control the internal temperature of the LOWER/RIGHT temperature zone. When you touch either key at the first time, the display will show the last temperature set previously.
- **IMPORTANT!** For non-Twin Wine Conditioning System, the temperature set for the LOWER temperature zone must always be just as high as or higher than that in the UPPER



temperature zone. For optimal performance, the set temperature of the two zones should differ by at least 4°C (7F°).

- The temperature that you desire to set will increase 1°C or 1°F if you touch the UP key once, on the contrary the temperature will decrease 1°C or 1°F if you touch the DOWN key once. The display flashes while you make the setting.
- After the temperature has been set, the display shows the current inner temperature of the particular temperature zone.
- To view the set temperature at any time, touch the UP or DOWN key, the set temperature will temporarily flash in the display for 5 seconds. Then the display shows the current inner temperature again.

## 6.4 Use and control – dual zone with lcd display



### The Controls of Your Unit



**POWER**  - To turn the appliance off, lightly touch and hold the  key for 5 seconds until temperature display goes out. To turn the appliance on, lightly touch and hold the  key for 1 second until temperature display lights up.

**NOTE!** Touching the  key once can switch off the audible alarm when the alarm is on.

**°F/°C SELECTOR**  - Set the temperature to be displayed in degree Fahrenheit or degree Celsius.



**LIGHT**  - To turn the interior light on/off, lightly touch and hold the  key for 5 seconds.











**UP**  - Used to increase (warm) the set temperature by 1°C/1°F.

**DOWN**  - Used to decrease (cool) the set temperature by 1°C/1°F.

**Setting Selector**  - Select the temperature and humidity you want to set.

### Symbols in the Display

- |   |   |
|---|---|
|  | Temperature or Error code display for upper/left zone.  |
|  | Temperature or Error code display for lower/right zone. |

	Compressor is ON
	Heater is ON
	Defrosting mode
	Dynamic Climate mode
DEMO	Eco Demo mode
	The interior light is in Showcase mode
	Warning
	Audible tones signal
	Child lock is activated
	Wifi connection signal
	Anti-condensation mode
	Relative humidity display

### Multi-key Function

To perform the multi-key function, lightly touch and hold the first key, then touch the rest key for at least 5 seconds and then release all the keys.

### Child Lock

(Only for models with outside controls) If in 2 minutes or longer without touching any key, the child lock will be activated automatically. To remove the lock, press the UP and DOWN keys at the same time for at least 5 seconds until the symbol  is go out.

### Setting the Temperature Control

- The unit has two separate temperature zones. The temperature of both zones can be set between 5°C and 20°C (41°F and 68°F). It can be used as a wine maturing cabinet or a wine serving cabinet. For maturing wine, the recommended temperature setting ranges of both zones should be between 11°C and 14°C (52°F and 57°F). For serving wine, the recommended temperature setting range of UPPER/LEFT zone should be between 5°C and 10°C (41°F and 50°F) which is ideal for serving champagne & white wine and the recommended temperature setting range of LOWER/RIGHT zone should be between 15°C and 20°C (58°F and 68°F) which is ideal for serving red wine.
- When the unit is plugged in for the first time, the unit will power up automatically to the preset defaults. The preset temperature at the factory for UPPER/LEFT temperature zone is 8°C (46°F) and for LOWER/RIGHT temperature zone is 12°C (54°F).
- Touch the **Setting Selector**  until the temperature you want to set is flashing. Then you can use the UP and DOWN keys to set the internal temperature as required. When you touch either key at the first time, the display will show the last temperature set previously.
- **IMPORTANT:** The temperature set for the LOWER temperature zone must always be just as high as or higher than that in the UPPER temperature zone.

- The temperature will increase 1°C/1°F if you touch the UP key once, or the temperature will decrease 1°C/1°F if you touch the DOWN key once. The display flashes while you make the setting.
- The set temperature will temporarily flash in the display for 5 seconds after the temperature has been set. Then the display shows the current inner temperature again.
- To view the set temperature at any time, touch the **Setting Selector**  key, the set temperature will temporarily flash in the display for 5 seconds. Then the display shows the current inner temperature again.

### Setting the Humidity Control

- Humidity level can be kept automatically for models with humidity pump.
- Touch the **Setting Selector**  until the humidity display is flashing. Now you can use the UP and DOWN key to choose the relative humidity setting from 50% to 80% and 00%. The set humidity will temporarily flash in the display for 5 seconds. Then the display shows the current inner humidity again. The humidity preset at the factory is 70% (ideal wine storage humidity).
- When 00% is selected, the humidity pump will be switched off. The humidity pump increases the energy consumption of the unit. If the function is not necessary, please switch it off. The rated energy consumption is based on the function is switched off.

## 6.5 Use and control – three zone with led display



### The Controls of Your Unit

#### Upper Control Unit



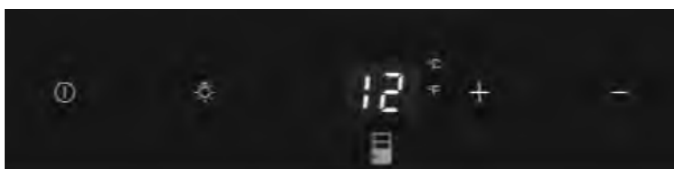

#### Lower Control Unit



**POWER**  - To turn the appliance off, lightly touch and hold the  key for 5 seconds until temperature display goes out. To turn the appliance on, lightly touch and hold the  key for 1 second until temperature display lights up.

**NOTE!** Touching the  key once can switch off the audible alarm when the alarm is on.

**LIGHT**  - To turn the interior light on/off, lightly touch and hold the  key for 5 seconds. The interior light indicator will light up or go out to confirm the selection.

**UP**  - Used to increase (warm) the set temperature by 1°C/1°F.

**DOWN**  - Used to decrease (cool) the set temperature by 1°C/1°F.

### Display

Display the digital temperature and service indicators.

 is for the **UPPER** temperature zone,  is for the **MIDDLE** temperature zone and

 is for the **LOWER** temperature zone.

### Light indicator / Multi-key Function

The interior light indicator is the dot at the bottom right of the display. The interior light indicator will light up in showcase mode. The indicator light is the dot at the bottom right of the display. The indicator light will be on when the multi-key function is selected. To perform the multi-key function, lightly touch and hold the first key, then touch the rest key for at least 5 seconds and then release all the keys.

### °F/°C Selector

Select the temperature display setting in Fahrenheit or Celsius degree. To change the temperature from Fahrenheit to Celsius or from Celsius to Fahrenheit, lightly touch and hold the LIGHT key for 5 seconds.

### Setting the Temperature Control

- The unit has three temperature zones. The temperature of all zones can be set separately. It can be used as a wine maturing and serving cabinet.
- The temperature settings of UPPER zone are adjustable with the range 11°-20°C (52°-68°F) which is ideal for serving red wine. The preset temperature at the factory is 18°C (65°F).
- The temperature settings of MIDDLE zone are adjustable with the range 5°-11°C (41°-52°F) which is idea for serving champagne and white wine. The preset temperature at the factory is 8°C (46°F).
- The temperature settings of LOWER zone are adjustable with the range 11°-13°C (52°-56°F) which is ideal for maturing wine. The preset temperature at the factory is 12°C (54°F) (ideal maturing temperature).
- Temperature control for the UPPER and MIDDLE temperature zones is at upper control unit. Temperature control for the LOWER temperature zone is at lower control unit.
- You can lightly touch the left side UP and DOWN keys to control the internal





temperature of corresponding zone. When you touch either key at the first time, the display will show the last temperature set previously.

- The temperature will increase 1°C or 1°F if you touch the UP key once, on the contrary the temperature will decrease 1°C or 1°F if you touch the DOWN key once. The display flashes while you make the setting.
- After the temperature has been set, the display shows the current inner temperature of the particular temperature zone.
- To view the set temperature at any time, touch the **UP** or **DOWN** key, the set temperature will temporarily flash in the display for 5 seconds. Then the display shows the current inner temperature again.

## 6.6 Use and control - three zone with lcd display



### The Controls of Your Unit



**POWER**  - To turn the appliance off, lightly touch and hold the  key for 5 seconds until temperature display goes out. To turn the appliance on, lightly touch and hold the  key for 1 second until temperature display lights up.

**NOTE!** Touching the  key once can switch off the audible alarm when the alarm is on.

**°F/°C SELECTOR**  - Set the temperature to be displayed in degree Fahrenheit or degree Celsius.



**LIGHT**  - To turn the interior light on/off, lightly touch and hold the  key for 5 seconds.











**UP**  - Used to increase (warm) the set temperature by 1°C/1°F.

**DOWN**  - Used to decrease (cool) the set temperature by 1°C/1°F.

**Setting Selector**  - Select the temperature and humidity you want to set.

### Symbols in the Display

	Temperature or Error code display for the upper zone.
	Temperature or Error code display for the middle zone.
	Temperature or Error code display for the lower zone.

	Compressor is ON
	Heater is ON
	Defrosting mode
	Dynamic Climate mode
DEMO	Eco Demo mode
	The interior light is in Showcase mode
	Warning
	Audible tones signal
	Child lock is activated
	Wifi connection signal
	Anti-condensation mode
RH % 	Relative humidity display

### Multi-key Function

To perform the multi-key function, lightly touch and hold the first key, then touch the rest key for at least 5 seconds and then release all the keys.

### Child Lock

(Only for models with outside controls) If in 2 minutes or longer without pressing any key, the child lock will be activated automatically. To remove the lock, lightly touch the UP and DOWN keys at the same time for at least 5 seconds until the symbol  is go out.

### Setting the Temperature Control

- The unit has three temperature zones. The temperature of all zones can be set separately. It can be used as a wine maturing and serving cabinet.
- The temperature settings of **UPPER** zone are adjustable with the range 11°-20°C (52°-68°F ) which is ideal for serving red wine. The preset temperature at the factory is 18oC (65°F ).
- The temperature settings of **MIDDLE** zone are adjustable with the range 5°-11°C (41°-52°F ) which is idea for serving champagne and white wine. The preset temperature at the factory is 8°C (46°F )
- The temperature settings of **LOWER** zone are adjustable with the range 11°-13°C (52°-56°F ) which is ideal for maturing wine. The preset temperature at the factory is 12°C (54°F ) (ideal maturing temperature).
- Touch the Setting Selector  until the temperature you want to set is flashing. Then you can use the **UP** and **DOWN** keys to control the internal temperature of corresponding zone. When you touch either key at the first time, the display will show the last temperature set previously.
- The temperature will increase 1°C or 1°F if you touch the UP key once, on the contrary the temperature will decrease 1°C or 1°F if you touch the DOWN key once. The display flashes while you make the setting.

- After the temperature has been set, the display shows the current inner temperature of the particular temperature zone.
- To view the set temperature at any time, touch the **Setting Selector**  key, the set temperature will temporarily flash in the display for 5 seconds. Then the display shows the current inner temperature again.

### **Setting the Humidity Level**

- Humidity level can be kept automatically for models with humidity pump.
- Touch the **Setting Selector**  until the humidity display is flashing. Now you can use the UP and DOWN key to choose the relative humidity setting from 50% to 80% and 00%. The set humidity will temporarily flash in the display for 5 seconds. Then the display shows the current inner humidity again. The humidity preset at the factory is 70% (ideal wine storage humidity).
- When 00% is selected, the humidity pump will be switched off. The humidity pump increases the energy consumption of the unit. If the function is not necessary, please switch it off. The rated energy consumption is based on the function is switched off.

### **Settings mode**

Certain settings on the wine cabinet can only be selected in settings mode.

#### **°F/°C Selection**

- Lightly touch and hold the UP key for 5 seconds.
- Use the UP and DOWN keys to select the temperature display setting in Fahrenheit or Celsius degree.
- Touch the POWER key to confirm your selection.
- Touch and hold the UP key for 5 seconds to leave settings mode. Otherwise the appliance exits settings mode automatically after approximately one minute.

#### **Display Brightness**

- Lightly touch and hold the UP key for 5 seconds and then touch the POWER key once.
- Use the UP and DOWN keys to select the brightness of the display. The factory default setting is d1.
  - » D1: dimmest setting
  - » D2: medium setting
  - » D3: brightest setting
- Touch the POWER key to confirm your selection.
- Touch and hold the UP key for 5 seconds to leave settings mode. Otherwise the appliance exits settings mode automatically after approximately one minute.

### **Interior Lighting Brightness**

- Lightly touch and hold the UP key for 5 seconds and then touch the POWER key twice.
- Use the UP and DOWN keys to select the brightness of the interior lighting. The factory default setting is L1.
  - » L1: dimmest setting
  - » L2: medium setting
  - » L3: brightest setting
- Touch the POWER key to confirm your selection.
- Touch and hold the UP key for 5 seconds to leave settings mode. Otherwise the appliance exits settings mode automatically after approximately one minute.

### **Fan Mode**

- Lightly touch and hold the UP key for 5 seconds and then touch the POWER key three times.
- Use the UP and DOWN keys to select the fan mode. The factory default setting is F0.
  - » F0: Silent mode - Energy saving mode
  - » F1: DynaClima mode - half time
  - » F2: DynaClima mode - full time
- Touch the POWER key to confirm your selection.
- Touch and hold the UP key for 5 seconds to leave settings mode. Otherwise the appliance exits settings mode automatically after approximately one minute.

### **Audible Tones**

- Lightly touch and hold the UP key for 5 seconds and then touch the POWER key four times.
- Use the UP and DOWN keys to select the audible tones. The factory default setting is S1.
  - » S0: sensor tone ON, alarm tone OFF
  - » S1: sensor tone ON, alarm tone ON
  - » S2: sensor tone OFF, alarm tone OFF
  - » S3: sensor tone OFF, alarm tone ON
- Touch the POWER key to confirm your selection.
- Touch and hold the UP key for 5 seconds to leave settings mode. Otherwise the appliance exits settings mode automatically after approximately one minute.

## Temperature display



During normal operation, the temperature display on the control panel shows the temperature inside the appliance. **The temperature display will flash if:**

- A different temperature is being set,
  - The temperature in the zone deviates by more than 5°C (9°F) from the set temperature.
- The temperature display flashing ensures that the temperature can not rise or fall unnoticed and impair the wine.

## Temperature memory function

In the event of a power interruption (power surge, breaker switch, etc.), the unit remembers the previous temperature settings. When the power is recovered, the cabinet temperature will go back the same setting temperature as before the power interruption.







## Temperature alarm

An audible alarm will sound if the temperature in one of the zones rises or falls outside the temperature range. The relevant temperature display will flash at the same time (And the symbols  &  will light up in the display for models with LCD Display).

The temperature the appliance is set at determines the temperature the appliance recognizes as being too warm or too cool.





The audible alarm will sound and the temperature display will flash:







- When you switch the appliance on, if the temperature inside the appliance is very different from the temperature set.
- When there has been a lengthy interruption to the power supply.
- When too many items have been put into the unit at one time. Or too much ambient air flowed in when rearranging and removing storage items.
- When the door is not been closed tightly.
- The appliance is faulty.

The audible alarm will be automatically silenced, the temperature display stops flashing (And the symbols  &  will go out for models with LCD Display) when the set temperature is reached again. However, if the noise disturbs you, you can switch the audible alarm off before this if you wish by touching the **POWER** key once. The alarm will stop. The relevant temperature display continues to flash (And the symbols  &  will continue to be lit up for models with LCD display) until the set temperature has been reached. The display then lights up constantly, the symbols  &  will go out for models with LCD display, and the alarm system is fully active again.

## Humidity alarm

A humidity audible alarm (if your model supplied with it) will sound if the humidity inside the unit rises or falls outside the humidity range. The relevant humidity display will flash at

the same time and the symbol  will light up. The flash of <sup>RH</sup> % LL and  indicates too low humidity level and the flash of  HH and  indicates too high humidity level.

The audible alarm will be automatically silenced, the humidity display stops flashing and the symbols  &  will go out when the set humidity range is reached again. However, if the noise disturbs you, you can switch the audible alarm off before this if you wish by touching the **POWER** key once. The alarm will stop. The relevant humidity display continues to flash and the symbols  &  will continue to be lit up until the set humidity has been reached. The display then lights up constantly, the symbols  &  will go out, and the alarm system is fully active again.

### **Door alarm**

If the door has been left open for more than 60 seconds, the audible alarm will sound (And the symbol  will light up for models with LCD display). Closing the door or touching the **POWER** key once can switch off the audible alarm.

### **DOOR OPENING MECHANISM (PUSH-TO-OPEN DOOR FUNCTION)**

The push-to-open door function (if your model supplied with it) is activated when the unit is powered. To open the door, push the door slightly inwards on the top left position for the right hinge model (the top right position for the left hinge model) and then release it. The door will be opened approx. 9cm by the push piston. Then the door can be fully open manually. The push piston will return to its initial position after 4 seconds automatically.

### **NOTE!**

- To protect against inadvertent opening, the door will close again by itself after approx. 4 seconds if you do not pull the door open manually for models with articulated hinges.
- Do not block the door or hold on it while it is opening. If the door is blocked or held during opening, the door opening mechanism and the door will be damaged. The loud and repeated cracking noises will be heard.
- Do not push the push piston in or hold on to it during closing. If the push piston is blocked during closing, it will no longer be able to reach its initial position. In the initial position, the push piston is flush with the front of cabinet. In order to set the push piston back in its initial position, disconnect the appliance from the mains, wait for approx. 10 seconds and plug it back in again. The push piston will return to its initial position.
- The system is not triggered immediately after the door is closed. Allow 3 seconds and try again. This is not a system failure.

The door on the unit is sensitive to pressure. The pressure sensitivity to open the door is possible to adjust as following steps:

1. Open the door.

2. Rotate the screw on the top middle of door counterclockwise to increase the sensitivity and clockwise to decrease the sensitivity.
3. Close the door and check if it is correctly adjusted. Rotating the screw counterclockwise too much can cause the door to open automatically even without pushing or just closing the door hard. In reverse rotating the screw clockwise too much can cause the door not to open even with heavy pushing.

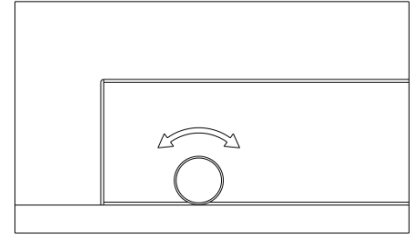

## INTERIOR LIGHT / TriColor LIGHTING

The interior light makes it easy to view your wine labels and enhances the display of your collection. Touching the **LIGHT** mark toggles between 2 modes of operation for the internal lights: functional (default) mode and showcase mode. If you are in functional (default) mode, the lights will turn on only when the door is open. The interior light will go out approx. 5 seconds after the door is closed. If you are in showcase mode, the lights will be on whether or not the door is open and the symbol  will light up for models with LCD display.

The unit is equipped with the LED type lights and they are designed for extremely long life. They are not user serviceable. To change them pls contact the service department.

**NOTE!** Please use only the original LED light fittings provided by the manufacturer.

If your model is provided a TriColor lighting, you can select the color of interior light - amber, white and blue by touching the **Color Selector** key . Touching the Color selector key toggles between single color mode and dynamic color mode. In the dynamic color mode the interior light will start to cycle through the 3 available colors. Touching the Color Selector key once when the desired color is on, your interior light will be changed to that color. To change back to the dynamic color mode, touch the Color Selector key again.

## 6.7 Different modes

### Dynaclima/silent mode

This DYNACLIMA (Dynamic Climate) mode enables the relative humidity inside the unit and the temperature to be distributed evenly around the interior so you can store all your wine under exactly the same excellent conditions. If you would like to use the unit to store wine long term, the DYNACLIMA mode is a must. This will create a continuous climate in the cabinet which imitates that of a wine cellar.

In the DYNACLIMA mode, the interior fan circulates the inside air evenly even when the set temperature is reached. To change to DYNACLIMA mode, touch and hold the DOWN key for approximately five seconds. The wine cellar will beep five times to confirm DYNACLIMA mode is on (And the symbol will light up for models with LCD Display). To change to SILENT

mode (Also known as energy saving mode), touch and hold the UP key for approximately five seconds. The wine cellar will beep three times to confirm default (SILENT) mode is on (And the symbol will go out for models with LCD Display).

### **Sabbath mode**

Sabbath mode is available for the observance of certain religious holidays. This mode turns off the displays, interior light and audible alarms and prevents them from turning on again. Normal cooling operations will still take place.

To initiate Sabbath mode, touch the POWER and LIGHT keys at the same time for at least 5 seconds. The displays and interior lights will go out and confirm the Sabbath mode is ON.

Sabbath mode can be canceled by repeating the above process. The Sabbath Mode will automatically turn off after 48 hours.

### **Eco demo mode**

Eco Demo mode can be activated by presenting the appliance at exhibitions or in salesrooms. In Eco Demo mode, the compressor and all fan motors are switched OFF.

Models with LED Display - by touching and holding the "UP"&"DOWN" (The controls of upper zone for dual zone & The controls of lower zone for three zone models) and "LIGHT" keys at the same time for at least 5 seconds, the indicator light will flash five times to confirm the input and the unit will operate in Eco Demo mode. Eco Demo mode can be canceled by repeating the above process.

Models with LCD Display - by touching and holding the "UP"&"DOWN" and "LIGHT" keys at the same time for at least 5 seconds, the symbol will light up to confirm the input and the unit will operate in Eco Demo mode. Eco Demo mode can be canceled by repeating the above process and the symbol **DEMO** will go out.

### **Anti-condensation mode**

Anti-condensation mode (if your model supplied with it) can prevent the condensation formed on the surface of glass door even in a climate with very high humidity. During seasons of high humidity, simply switch on the mode. The condensation will disappear shortly. The mode increases the energy consumption of the wine cellar, if this mode is not needed, please switch it off. The switch  is located on the control panel. I is ON and O is OFF. The rated energy consumption is based on the function is switched off.

## **6.8 Bottle loading, noises and hygometry**

### **Bottle racks and storage**

- **WARNING!** Do not pull out more than one loaded shelf at a time as this may cause the unit to tilt forward.
- **WARNING!** Do not pull out the shelf where the stacked bottles are loaded.
- **WARNING!** To prevent the bottles from falling, do not try to slide the shelves outward



beyond the fixed position.

- **WARNING!** To prevent damaging the door gasket, make sure the door is fully open when pulling shelves out of the compartment.
- **IMPORTANT:** Do not cover any part of the shelves with aluminum foil or any other material that will prevent adequate air circulation within the cabinet.

All the wine racks slide out for easy access, except for the bottom fixed shelf. For easy access to the bottles stored, pull the rack out gently until it stops. The shelves are designed with an emergency stop to prevent them being moved too far when loaded.

Many bottles may differ in size and dimensions. As such the actual number of bottles you may be able to store may vary.

Bottle capacities are approximate maximums when storing traditional Bordeaux 750ml bottles and including bulk storage.

You may load your wine bottles in single rows or by stacking while taking note of the following - if you do not have enough bottles to fill your wine cellar, it is better to distribute the load throughout the wine cellar so as to avoid "all on top" or "all below" type loads.

- Do not remove or relocate adjustable wooden racks to accommodate larger types of bottles or increase the capacity of the cellar by tacking the bottles up when necessary. (See *Removing Shelves*)
- Keep small gaps between the walls and the bottles to allow air circulation. Like an underground cellar, air circulation is important to prevent mold and promote a better homogeneous temperature.
- To facilitate air circulation, do not overload your wine cellar.
- Lay the bottles flat.
- Avoid obstructing the internal fans (located inside on the back panel of the unit).
- Do not cross contaminate. Store only wine in your unit to ensure that the environment is odor free.
- Only store wine in unopened bottles. Storing opened bottles may result in spillage.

### **Operating noises**

The unit is cooled by a compressor (refrigeration aggregate). The compressor pumps coolant through the cooling system, producing operating noise. Even when the compressor cuts out, noises caused by changes in temperature and pressure are unavoidable. Operating noise will be most audible immediately after the compressor cuts in. It becomes quieter as the operating period continues.

The following noises are normal and occur from time to time:

- Gurgling sound, caused by the refrigerant flowing through the appliance's coils,

- Humming noise made by the motor compressor. This noise can get louder for brief periods when the motor is switching on.
- Crackling/popping sounds, resulting from the materials contraction and expansion due to temperature variations,
- Fan operating sound, to circulate the air within the wine cabinet.

Unusual noise is normally the result of improper installation. Under no circumstances must tubing come into contact with a wall, other furniture or with other tubing.

Where the unit is installed in an open-plan kitchen or in partition walls, the level of operating noise will be heard more acutely. However, this is due to the surrounding architecture and not to the unit.

*An individual's perception of noise is directly linked to the environment in which the unit is located, as well as the specific type of model. Our appliances are in line with international standards for such appliances and in line with the latest technical developments. But please remember that the noise of the compressor and the coolant circulating in the system is unavoidable.*

### **Defrosting/hygrometry/ventilation**

Your unit is designed with an automatic defrost system. During the "Off-cycle" the evaporator behind the rear wall of the unit defrosts automatically. The condensate collects in the drain trough behind the rear wall of the unit, and part of it flows through the drainage hole into the drip tray by/above the compressor. The heat is transferred from the discharge pipe or compressor and evaporates any condensation that has collected in the tray. Part of the remaining water is collected within the unit for humidity purposes.

This system enables the creation of the correct humidity level inside your unit required by the natural cork to maintain a long lasting seal and gives the cabinet natural ventilation and constant air circulation.

The appliance is not totally sealed: fresh air admission is permitted through the drainpipe and/or air exchange pipe. Air is circulated through the unit by means of a fan / fans and the open shelves.

**NOTE!** Frost may be accumulated on the evaporator if the unit is repeatedly opened in a high heat or high humidity location. If this frost pattern does not clear within 24 hours, your unit will require manual defrosting.

### **Wine serving temperature chart**

All wines mature at the same temperature, which is a constant temperature set between 11°C to 14°C. The chart below indicates the best temperature for drinking various types of wine.

<b>Wine Style</b>	<b>°C</b>	<b>°F</b>
Champagne NV, Sparkling, Spumante	6	43
Dry White Semillon, Sauvignon Blanc	8	46
Champagne Vintage	10	50
Dry White Chardonnay	10	50
Dry White Gewürztraminer, Riesling, Pinot grigio	10	50
Sweet White Sauternes, Barsac, Montbazillac, Ice Wine, Late Harvest	10	50
Beaujolais	13	55
Sweet White Vintage: Sauternes...	14	57
White Vintage Chardonnay	14	57
Red Pinot Noir	16	61
Red Grenache, Syrah	16	61
Red Vintage Pinot Noir	18	65
Cabernet & Merlot: French, Australian, New Zealand, Chilean, Italian, Spanish, Californian, Argentinean...	20	68
Vintage Bordeaux...	Room temperature not exceeding 20 °C/68 °F	

**TIP:** Store the wine 1 or 2°C cooler than the recommended drinking temperature as it warms up a little when poured into the glass.

**TIP:** Full-bodied reds should be opened for 2-3 hours before drinking to allow the wine to breathe and develop its aroma.

### **Important information about temperature**

Your unit has been designed to guarantee optimum conditions for storing and/or serving your wines.

Fine wines require long and gentle developments and need specific conditions in which to reach their full potential.

All wines mature at the same temperature, which is a constant temperature set between 11°C to 14°C. Only the temperature of "dégustation" (wine appreciation) varies according to the type of wines (see the Wine Serving Temperature Chart as above). This being said and as it is for natural cellars used by wine producers for long period of storage, it is not the exact temperature that is important, but its consistency. In other words, as long as the temperature of your wine cellar is constant (between 11°C to 14°C, or 52°F to 57°F) your wines will be stored under perfect conditions.

Not all wines will improve over the years. Some should be consumed at an early stage (2 to 3 years) while others have tremendous ageing capability (50 years and over). All wines have a peak in maturity. Check with your wine merchant to get the relevant information.

At too high a temperature (over 22 °C) wine matures too quickly, which prevents the aromas from developing further. Wine cannot mature fully at too low a temperature (below 5 °C).

Fluctuations in temperature put wine under stress and interrupt the maturing process. It is therefore very important to maintain a constant temperature.

## 7. CARE AND MAINTENANCE

**WARNING!** Failure to unplug the appliance during service and cleaning could result in electrical shock or other personal injury.

### Removing shelves

To remove any of the shelves from the rail compartment, move the shelf to the position where the notch of the wooden shelf is exactly under the plastic rack stop and then lift it up and out.

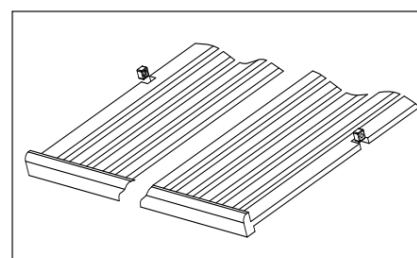

In order to replace the shelf, repeat steps described above in reverse. And make sure to engage the shelves with the small pegs of the extended rails when the model is equipped with part extension slides.

For models with full extension slides, to remove a shelf, extend the shelf out of the rail compartment until it stops and remove all bottles from the shelf. Then lift the shelf front straight up and then grasp the slides (2) and push the shelf (1) straight inward to release the shelf from the slides. In order to replace the shelf, repeat this procedure in reverse.

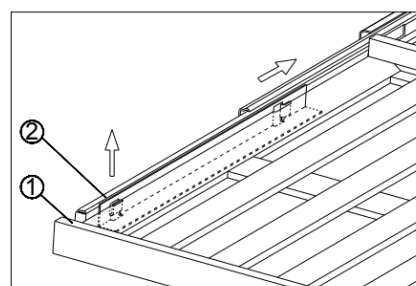

### Humidity control

The appliance is equipped with a system for maintaining the correct level of humidity. Under extremely dry environmental conditions, you may have to add some water into the humidity box provided with your wine cellar.

Fill the small plastic reservoir (humidity box) 3/4 full with water, and fit onto the runners found on the shelf of the appliance. Check the water level regularly and refill as necessary.

Please ensure the reservoir is positioned correctly on the runners on the shelf to avoid the possibility of water spillage.

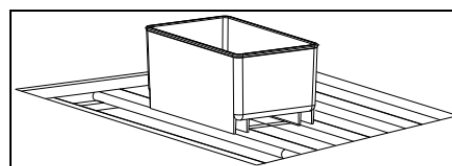

For models with humidity pump, please add around 500ml steamed water into the drain trough softly when starting to use the unit at the first time. The water can insure the unit with correct humidity in the next around six months. If the humidity alarm indicates low humidity level, please add another 500ml steamed water into the drain trough.

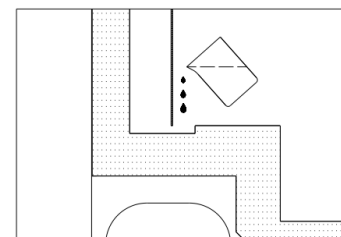

Too high humidity level inside the cabinet will not spoil the stored wines but mildew and mould may appear and labels may get unstuck.

### **Active charcoal air filter**

The active charcoal air filter (if your model supplied with it) is located in the back of compartment. Replace it with a new one once a year. It can be purchased from your dealer or from the Spare Parts Department.

1. Remove the shelf in front of the filter.
2. Grip the filter and turn it 90° clockwise or anti-clockwise to remove.
3. Insert the new filter in the vertical position and turn it 90° clockwise or anti-clockwise until it clicks into position.

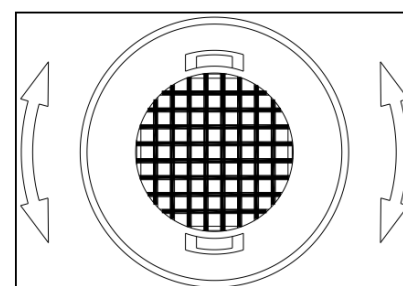

### **Door lock**

If the unit is provided with a lock system, the keys are located inside the plastic bag that contains the Owner's Manual. Insert the key into the lock, push in and turn it counterclockwise to unlock the door. To lock the door do the reverse operation making sure metal pin is engaged completely. Remove the key and place it in a secure place for safekeeping.

### **Cleaning your appliance**

Turn off the power, unplug the appliance, and remove all items including shelves and rack.

Wash the inside surfaces with a warm water and baking soda solution. The solution should be about 2 tablespoons of baking soda to a quart of water.

Wash the shelves with a mild detergent solution.

Wring excess water out of the sponge or cloth when cleaning any area of the controls.

The sealing gasket around the door must be cleaned regularly to prevent discoloration and prolong service life. Use clean water. After cleaning the sealing gasket, check that it continues to provide a tight seal.

Wash the outside cabinet with warm water and mild liquid detergent. Rinse well and wipe dry with a clean soft cloth.

**Do not clean the stainless steel with steel wool pads.** We suggest using an all-in-one stainless steel cleaner to clean the stainless steel. Always clean in the direction of the grain.

### **Power failure**

In the event of a power interruption, all previous temperature settings are automatically memorized. If power is interrupted (power surge, breaker switch, etc.) and then powered up again, the unit will operate with the last temperature set-point.

Most power failures are corrected within a few hours and should not affect the temperature of your appliance if you minimize the number of times the door is opened. If the power is going to be off for a longer period of time, you need to take the proper steps to protect your contents.

**NOTE!** Irrespective of the cause, if you notice either abnormal temperature or humidity levels inside your unit, be reassured that only long and frequent exposure to these abnormal conditions can cause a detrimental effect on your wines.

### **Vacation time**

- **Short holidays:** Leave the unit in operation for holidays of less than three weeks.
- **Long absences:** If the appliance will not be used for several months, remove all items, turn off the appliance and unplug. Clean and dry the interior thoroughly. To prevent odor and mold growth, leave the door open slightly, blocking it open if necessary.

### **Moving your appliance**

- Unplug the power plug from the electrical outlet.
- Remove the contents from the racks and all moving parts from inside.
- Raise the adjustable legs up to the base to avoid damage.
- Tape the door shut and lock it if with a lock system.
- Transport the unit only in the upright position. Also protect the outside of the appliance with a blanket or similar item.

### **Energy saving tips**

Should the unit be left empty for long periods of time, it is suggested that the appliance is unplugged, and after careful cleaning, leave the door ajar to allow air to circulate inside the cabinet in order to avoid possible condensation, mold or odors forming.

The appliance should be installed in the coolest area of the room, away from heat producing appliances, and out of the direct sunlight.

Ensure that the unit is adequately ventilated. Never cover air vents. Clean dust and dirt from the condenser at regular intervals.

Only open the door for as long as necessary and for as short a time as possible.

Store the content in an organized way.

To allow air to circulate, do not overfill the appliance.

## 8. PROBLEMS WITH YOUR APPLIANCE

You can solve many common problems easily, saving you the cost of a possible service call. Try the suggestions below to see if you can solve the problem before calling customer service.

### 8.1 Troubleshooting guide

PROBLEM	POSSIBLE CAUSE	REMEDY
Nothing works. Appliance does not operate.	<ul style="list-style-type: none"> <li>• Appliance is not connected to a power supply.</li> <li>• The appliance is turned off.</li> <li>• Circuit breaker has tripped or a fuse has blown.</li> </ul>	<ul style="list-style-type: none"> <li>• Connect the appliance.</li> <li>• Switch on the appliance.</li> <li>• Switch on circuit breaker or replace fuse.</li> </ul>
Appliance is not cold enough.	<ul style="list-style-type: none"> <li>• The temperature is not set correctly.</li> <li>• The ambient temperature could require a different temperature setting.</li> <li>• The door was opened too often.</li> <li>• The door was not closed completely.</li> <li>• Door is not hermetically sealed.</li> <li>• The condenser is too dirty.</li> <li>• The ventilation opening is blocked or too dusty.</li> </ul>	<ul style="list-style-type: none"> <li>• Check the set temperature.</li> <li>• Set a different temperature.</li> <li>• Do not open the door more often than necessary.</li> <li>• Close door properly.</li> <li>• Check the door seal and clean or replace.</li> <li>• Clean the obstructions and clean off the dust.</li> </ul>
Appliance turns itself on and off frequently.	<ul style="list-style-type: none"> <li>• The room temperature is higher than average.</li> <li>• A large amount of bottles has been added to the unit.</li> <li>• The door is opened too often.</li> <li>• The door is not closed completely.</li> <li>• The door gasket does not seal properly.</li> </ul>	<ul style="list-style-type: none"> <li>• Put the appliance in a cooler place.</li> <li>• Leave the appliance to work for a while until the set temperature has been reached.</li> <li>• Do not open the door more often than necessary.</li> <li>• Close door properly.</li> <li>• Check the door seal and clean or replace.</li> </ul>

The light does not come on.	<ul style="list-style-type: none"> <li>Appliance is not connected to a power supply.</li> <li>Circuit breaker has tripped or a fuse has blown.</li> <li>The light was switched off on the control panel.</li> <li>Light malfunctioning.</li> </ul>	<ul style="list-style-type: none"> <li>Connect the appliance.</li> <li>Switch on circuit breaker or replace fuse.</li> <li>Switch on the light.</li> <li>Call for service to have it replaced.</li> </ul>
Door will not open.	<ul style="list-style-type: none"> <li>Door locked.</li> </ul>	<ul style="list-style-type: none"> <li>Unlock the door.</li> </ul>
Vibrations.	<ul style="list-style-type: none"> <li>The appliance is not properly level.</li> </ul>	<ul style="list-style-type: none"> <li>Level the appliance with the adjustable feet.</li> </ul>
The appliance seems to make too much noise.	<ul style="list-style-type: none"> <li>The rattling noise may come from the flow of the refrigerant, which is normal. As each cycle ends, you may hear gurgling sounds caused by the flow of refrigerant in your appliance.</li> <li>If temperature fluctuations occur, the contractions and expansion of the inner walls may cause popping and cracking noises.</li> </ul>	
	<ul style="list-style-type: none"> <li>The appliance is not properly level.</li> </ul>	<ul style="list-style-type: none"> <li>Level the appliance with the adjustable feet.</li> </ul>
The door will not close properly.	<ul style="list-style-type: none"> <li>The appliance is not properly level.</li> <li>The door was reversed and not properly re-installed.</li> <li>The gasket is dirty.</li> <li>The shelves are out of position.</li> </ul>	<ul style="list-style-type: none"> <li>Level the appliance with the adjustable feet.</li> <li>Check the door hinge and reassemble correctly.</li> <li>Clean the door gasket.</li> <li>Check the shelves and refit correctly.</li> </ul>
<b>E0, E1, E2, E3, E4, E5, E6 or E7</b> appears on the display.	<ul style="list-style-type: none"> <li>Error codes.</li> </ul>	<ul style="list-style-type: none"> <li>Try resetting the controls by disconnecting power to the unit for 5 minutes, then reconnect. If error code returns, problem cannot be resolved by user. Call for service.</li> </ul>
Alarm sounds and temperature display <b>NOT</b> flashing (door alarm).	<ul style="list-style-type: none"> <li>Door has been left open longer than 60 seconds.</li> </ul>	<ul style="list-style-type: none"> <li>Close door, or touch <b>POWER</b> key to disable alarm. Alarm will reset when door is closed.</li> </ul>



<p>The alarm sounds <b>AND</b> the temperature display flashes (temperature alarm) .</p>	<ul style="list-style-type: none"> <li>• Has the appliance door been open for longer than 60 seconds? If not, then the temperature has risen higher or fallen lower than the temperature that has been set. This could be due to: <ul style="list-style-type: none"> <li>• The appliance door being opened too often.</li> <li>• The ventilation opening being covered or too dusty.</li> <li>• A lengthy interruption to the power supply.</li> <li>• A large amount of bottles has been added to the unit.</li> </ul> </li> </ul>	<ul style="list-style-type: none"> <li>• If yes, close the door. <ul style="list-style-type: none"> <li>• Do not open the door more than necessary.</li> <li>• Clean the obstructions and clean the dust.</li> <li>• Leave the appliance to work for a while until the set temperature has been reached.</li> </ul> </li> </ul>
<p>The icon dashes "--" is lit up and flashing in the temperature display.</p>	<ul style="list-style-type: none"> <li>• The temperature display is out of the range.</li> </ul>	<ul style="list-style-type: none"> <li>• Only temperatures within the range 16 to 99°F (-9 to 37°C) can be displayed. If the temperature is not within this range, the icon dashes "--" will be displayed instead. That is normal. Keep door closed and allow unit to cool to set temperature.</li> </ul>
<p>Condensation on outside surfaces of glass door.</p>	<ul style="list-style-type: none"> <li>• High humidity climate.</li> </ul>	<ul style="list-style-type: none"> <li>• During periods of high humidity, some condensation may appear on outside surfaces of glass door. It will disappear when humidity levels drop. It is advisable to install the appliance with sufficient ventilation in a dry and/or an air-conditioned place.</li> </ul>

## 9. WARRANTY

The statutory warranty period applies. If the product is defective, please contact your local distributor.

In case you need any services, please include the following documents when you send in the device:

- A copy of the receipt with purchasing date.
- A reason for the claim or description of the fault.

The warranty does not cover:

1. Damage in transit or when moving the appliance.
2. Any damages caused from negligence, accident, improper use, improper installation/service or use for purposes other than those described in the instruction manual.
3. Damage caused by connecting your product to the wrong power source.
4. Damage from power failure.
5. Faulty installation or modification made during installation.
6. Damage caused by unauthorized repair.
7. Any damages resulting from force majeure, fire disaster or natural disaster.
8. Alterations to the product without express permission from the manufacturer.
9. Parts such as light, removable shelves, glasses or plastic.
10. Any spoilage or damage to wines or any other contents incidental or consequential to possible defects of the unit.

**NOTE!** The warranty clauses and specifications are subject to change without notice.

**Customer Service:** [info@winestoragecompany.co.uk](mailto:info@winestoragecompany.co.uk)